

1. Product dimension:

ICL-LPL-IP50-600mm-SMD2835-28W



2. Key features

1. 100 lm/W , a direct replacement for T8(2*18W) ,50% energy saving .
2. 120D beam available for optimal lighting effects
3. High impact PC diffuser with internal linear prisms ensures uniformity of light
4. Extruded aluminum housing , anodized ,corrosion resistant
5. Injection-molded PC end caps
6. Integrated LED light engine eliminates the need for relamping
7. Fixtures can be connected for long continuous runs
8. Emergency and occupancy sensing versions are available
9. 5-year warranty offers complete peace of mind

3. Specification

| Model No. | Spec |
|--------------------------------|------------------------------|
| ICL-LPL-IP50-600mm-SMD2835-28W | |
| Input Power | 28W |
| Light output: | 2,800lm |
| Efficacy: | 100lm/W |
| LED lampl: | SMD2835 LEDs |
| CCT: | 3000K ,4000K ,5000K |
| CRI | 80 |
| Bean angle: | 120D |
| Optical cover: | Polycarbonate ,opal |
| LED driver: | MeanWell/Philips |
| Input voltage: | 90-305V AC,50/69Hz |
| Dimming: | Fixed output ,1-10V,DALI |
| Optional functions: | Emergency ,Occupancy Sensing |
| IP rating: | IP50 |
| Lifetime: | 50,000hrs |
| Mounting: | Surface,Suspended |

4. Dimension and Photometrics

Dimensions

Weight: 1.3 kg



Photometrics

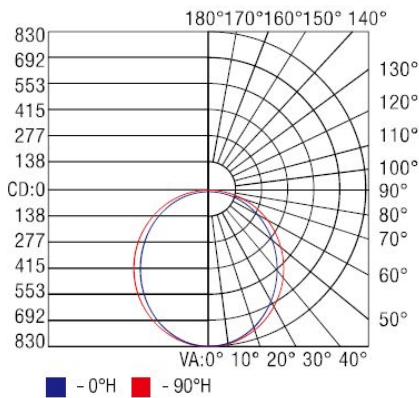

| | Center Beam lux | Beam Width |
|----|-----------------|-------------|
| 1m | 822.3 lux | 2.9m 3.5m |
| 2m | 205.6 lux | 5.8m 7.0m |
| 3m | 91.4 lux | 8.6m 10.5m |
| 4m | 51.4 lux | 11.5m 14.0m |
| 5m | 32.9 lux | 14.4m 17.6m |

Vertical:110.4°
 Horizontal:120.7°

5. Application information



1. Production line
2. Warehouses
3. Car parks
4. Subways
5. Shopping malls

6. Package & Certification

| Item | Dimensions(L*W*H) | Qty | G.W |
|--------------------------------|-------------------|------|-------|
| ICL-LPL-IP50-600mm-SMD2835-28W | 660*360*230mm | 6pcs | 9.0KG |

1. Product dimension:

ICL-LPL-IP50-900mm-SMD2835-36W



2. Key features

1. 100 lm/W , a direct replacement for T8(2*36W) , T5(2*28W) ,50% energy saving
2. 120D beam available for optimal lighting effects
3. High impact PC diffuser with internal linear prisms ensures uniformity of light
4. Extruded aluminum housing , anodized ,corrosion resistant
5. Injection-molded PC end caps
6. Integrated LED light engine eliminates the need for relamping
7. Fixtures can be connected for long continuous runs
8. Emergency and occupancy sensing versions are available
9. 5-year warranty offers complete peace of mind

3. Specification

| Model No. | Spec |
|--------------------------------|------------------------------|
| ICL-LPL-IP50-900mm-SMD2835-36W | |
| Input Power | 36W |
| Light output: | 3,600lm |
| Efficacy: | 100lm/W |
| LED lampl: | SMD2835 LEDs |
| CCT: | 3000K ,4000K ,5000K |
| CRI | 80 |
| Beam angle: | 120D |
| Optical cover: | Polycarbonate ,opal |
| LED driver: | MeanWell/Philips |
| Input voltage: | 90-305V AC,50/60Hz |
| Dimming: | Fixed output ,1-10V,DALI |
| Optional functions: | Emergency ,Occupancy Sensing |
| IP rating: | IP50 |
| Lifetime: | 50,000hrs |
| Mounting: | Surface,Suspended |

4. Dimension and Photometrics

Dimensions

Weight: 1.9 kg

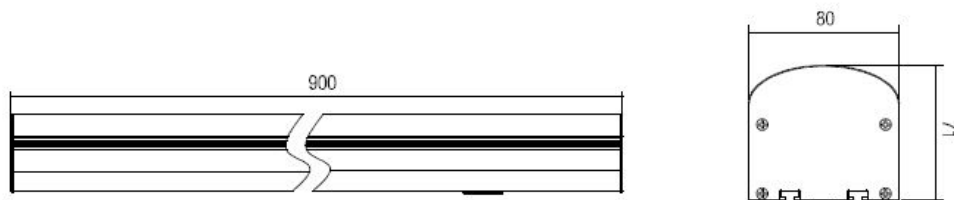

Photometrics

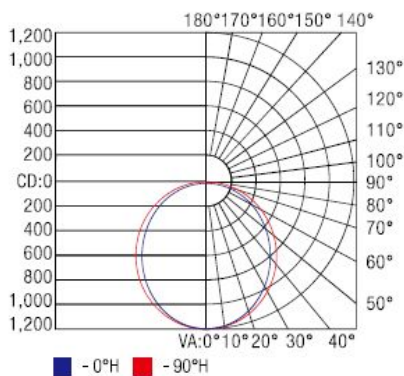

| | Center Beam lux | Beam Width |
|----|-----------------|-------------|
| 1m | 1,172.7 lux | 2.7m 3.4m |
| 2m | 293.2 lux | 5.5m 6.8m |
| 3m | 130.3 lux | 8.2m 10.2m |
| 4m | 73.3 lux | 10.9m 13.6m |
| 5m | 46.9 lux | 13.7m 17.0m |

■ Vertical: 107.5° ■ Horizontal: 119.1°

5. Application information



- 6. Production line
- 7. Warehouses
- 8. Car parks
- 9. Subways
- 10. Shopping malls

6. Package & Certification

| Item | Dimensions(L*W*H) | Qty | G.W |
|--------------------------------|-------------------|------|--------|
| ICL-LPL-IP50-900mm-SMD2835-36W | 960*360*230mm | 6pcs | 13.4KG |

1. Product dimension:

ICL-LPL-IP50-1200mm-SMD2835-45W



2. Key features

1. 100 lm/W , a direct replacement for T8(2*36W) ,T5(2*28W) ,50% energy saving .
2. 120D beam available for optimal lighting effects
3. High impact PC diffuser with internal linear prisms ensures uniformity of light
4. Extruded aluminum housing , anodized ,corrosion resistant
5. Injection-molded PC end caps
6. Integrated LED light engine eliminates the need for relamping
7. Fixtures can be connected for long continuous runs
8. Emergency and occupancy sensing versions are available
9. 5-year warranty offers complete peace of mind

3. Specification

| Model No. | Spec |
|---------------------------------|------------------------------|
| ICL-LPL-IP50-1200mm-SMD2835-45W | |
| Input Power | 45W |
| Light output: | 4,500lm |
| Efficacy: | 100lm/W |
| LED lampl: | SMD2835 LEDs |
| CCT: | 3000K ,4000K ,5000K |
| CRI | 80 |
| Bean angle: | 120D |
| Optical cover: | Polycarbonate ,opal |
| LED driver: | MeanWell/Philips |
| Input voltage: | 90-305V AC,50/60Hz |
| Dimming: | Fixed output ,1-10V,DALI |
| Optional functions: | Emergency ,Occupancy Sensing |
| IP rating: | IP50 |
| Lifetime: | 50,000hrs |
| Mounting: | Surface,Suspended |

4. Dimension and Photometrics

Dimensions

Weight: 2.5 kg



Photometrics

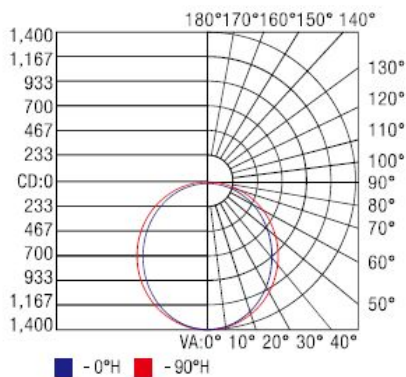

| | Center Beam lux | Beam Width |
|----|-----------------|--|
| 1m | 1,353.7 lux | 2.9m 3.4m |
| 2m | 338.4 lux | 5.8m 6.9m |
| 3m | 150.4 lux | 8.7m 10.3m |
| 4m | 84.6 lux | 11.5m 13.8m |
| 5m | 54.1 lux | 14.4m 17.2m |

■ Vertical:110.5° ■ Horizontal:119.7°

5. Application information



- 11. Production line
- 12. Warehouses
- 13. Car parks
- 14. Subways
- 15. Shopping malls

6. Package & Certification

| Item | Dimensions(L*W*H) | Qty | G.W |
|-------------------------------------|-------------------|------|--------|
| ICL-LPL-IP50-1200mm-SMD2835 -45W | 1260*360*230mm | 6pcs | 17.1KG |

1. Product dimension:

ICL-LPL-IP50-1500mm-SMD2835-60W



2. Key features

1. 100 lm/W , a direct replacement for T8(2*58W) ,T5(2*54W) ,50% energy saving .
2. 120D beam available for optimal lighting effects
3. High impact PC diffuser with internal linear prisms ensures uniformity of light
4. Extruded aluminum housing , anodized ,corrosion resistant
5. Injection-molded PC end caps
6. Integrated LED light engine eliminates the need for relamping
7. Fixtures can be connected for long continuous runs
8. Emergency and occupancy sensing versions are available
9. 5-year warranty offers complete peace of mind

3. Specification

| Model No. | Spec |
|---------------------------------|------------------------------|
| ICL-LPL-IP50-1500mm-SMD2835-60W | |
| Input Power | 60W |
| Light output: | 6,000lm |
| Efficacy: | 100lm/W |
| LED lamp: | SMD2835 LEDs |
| CCT: | 3000K ,4000K ,5000K |
| CRI | 80 |
| Beam angle: | 120D |
| Optical cover: | Polycarbonate ,opal |
| LED driver: | MeanWell/Philips |
| Input voltage: | 90-305V AC,50/60Hz |
| Dimming: | Fixed output ,1-10V,DALI |
| Optional functions: | Emergency ,Occupancy Sensing |
| IP rating: | IP50 |
| Lifetime: | 50,000hrs |
| Mounting: | Surface,Suspended |

4. Dimension and Photometrics

Dimensions

Weight: 3.0 kg

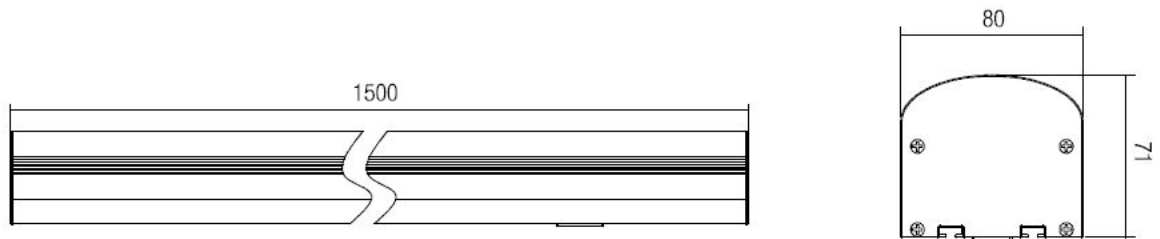

Photometrics

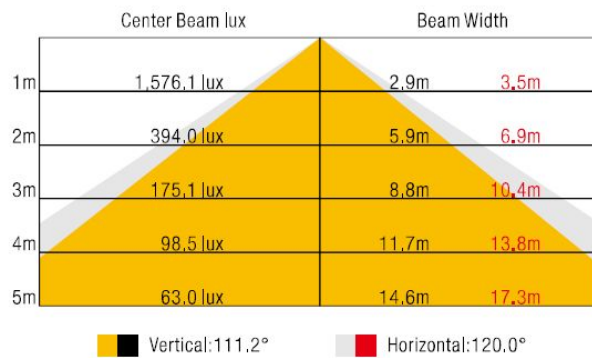
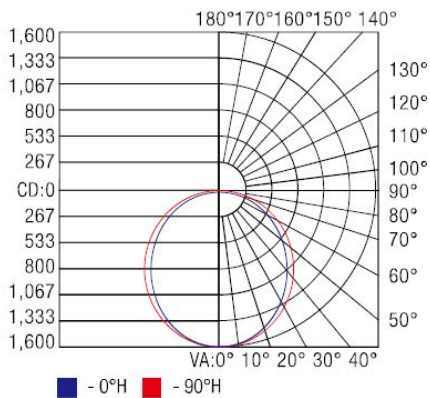

5. Application information



- 16. Production line
- 17. Warehouses
- 18. Car parks
- 19. Subways
- 20. Shopping malls

6. Package & Certification

| Item | Dimensions(L*W*H) | Qty | G.W |
|-------------------------------------|-------------------|------|--------|
| ICL-LPL-IP50-1500mm-SMD2835 -60W | 1560*360*230mm | 6pcs | 21.0KG |

1. Product dimension:

ICL-LPL-IP65-600mm-SMD2835-28W



2. Key features

1. 100 lm/W , a direct replacement for T8(2*18W) ,50% energy saving .
2. 120D beam available for optimal lighting effects
3. High impact PC diffuser with internal linear prisms ensures uniformity of light
4. Extruded aluminum housing , anodized ,corrosion resistant
5. Injection-molded PC end caps
6. Integrated LED light engine eliminates the need for relamping
7. A range of mounting options for use in different applications
8. Emergency and occupancy sensing versions are available
9. 5-year warranty offers complete peace of mind

3. Specification

| Model No. | Spec |
|--------------------------------|------------------------------|
| ICL-LPL-IP65-600mm-SMD2835-28W | |
| Input Power | 28W |
| Light output: | 2,800lm |
| Efficacy: | 100lm/W |
| LED lamp: | SMD2835 LEDs |
| CCT: | 3000K ,4000K ,5000K |
| CRI | 80 |
| Beam angle: | 120D |
| Optical cover: | Polycarbonate ,opal |
| LED driver: | MeanWell/Philips |
| Input voltage: | 90-305V AC,50/60Hz |
| Dimming: | Fixed output ,1-10V,DALI |
| Optional functions: | Emergency ,Occupancy Sensing |
| IP rating: | IP65 |
| Lifetime: | 50,000hrs |
| Mounting: | Suspended/Ceiling/Wall |

4. Dimension and Photometrics

Dimensions

Weight: 1.6 Kg

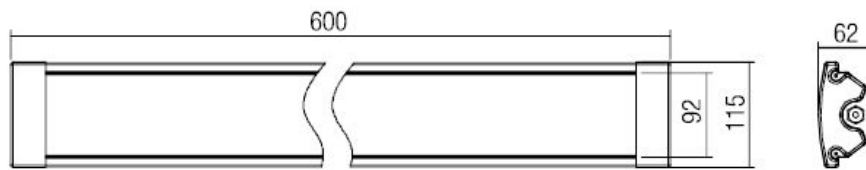

Photometrics

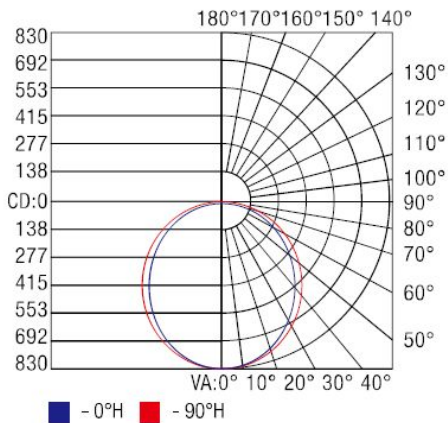

| | Center Beam lux | Beam Width |
|----|-----------------|---------------|
| 1m | 822,3 lux | 2,9m / 3,5m |
| 2m | 205,6 lux | 5,8m / 7,0m |
| 3m | 91,4 lux | 8,6m / 10,5m |
| 4m | 51,4 lux | 11,5m / 14,0m |
| 5m | 32,9 lux | 14,4m / 17,6m |

Vertical: 110,4° Horizontal: 120,7°

5. Application information

- 1.Underpasses
- 2.Subways
- 3.Warehouses
- 4.Cae parks

6. Package & Certification

| Item | Dimensions(L*W*H) | Qty | G.W |
|--------------------------------|-------------------|------|--------|
| ICL-LPL-IP65-600mm-SMD2835-28W | 660*470*220mm | 6pcs | 10.8KG |

7. Mounting

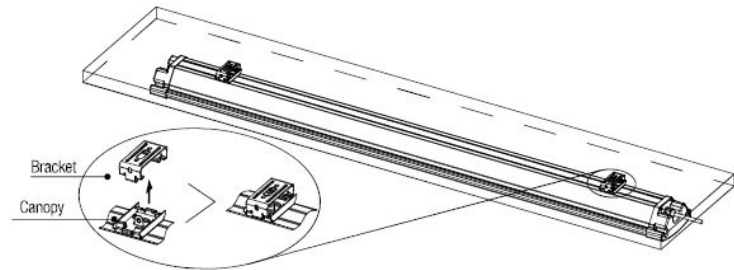
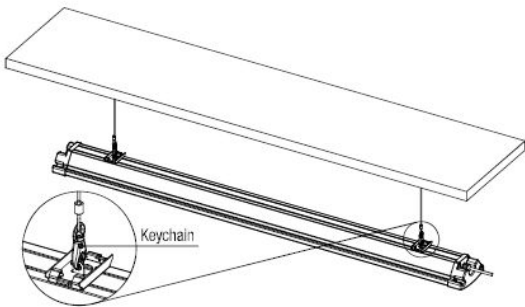

1. Product dimension:

ICL-LPL-IP65-900mm-SMD2835-36W



2. Key features

1. 100 lm/W , a direct replacement for T8(2*36W) , T5(2*28W), 50% energy saving .
2. 120D beam available for optimal lighting effects
3. High impact PC diffuser with internal linear prisms ensures uniformity of light
4. Extruded aluminum housing , anodized , corrosion resistant
5. Injection-molded PC end caps
6. Integrated LED light engine eliminates the need for relamping
7. A range of mounting options for use in different applications
8. Emergency and occupancy sensing versions are available
9. 5-year warranty offers complete peace of mind

3. Specification

| Model No. | Spec |
|--------------------------------|------------------------------|
| ICL-LPL-IP65-900mm-SMD2835-36W | |
| Input Power | 36W |
| Light output: | 3,600lm |
| Efficacy: | 100lm/W |
| LED lampl: | SMD2835 LEDs |
| CCT: | 3000K ,4000K ,5000K |
| CRI | 80 |
| Bean angle: | 120D |
| Optical cover: | Polycarbonate ,opal |
| LED driver: | MeanWell/Philips |
| Input voltage: | 90-305V AC,50/60Hz |
| Dimming: | Fixed output ,1-10V,DALI |
| Optional functions: | Emergency ,Occupancy Sensing |
| IP rating: | IP65 |
| Lifetime: | 50,000hrs |
| Mounting: | Suspended/Ceiling/Wall |

4. Dimension and Photometrics

Dimensions

Weight: 2.2 Kg



Photometrics

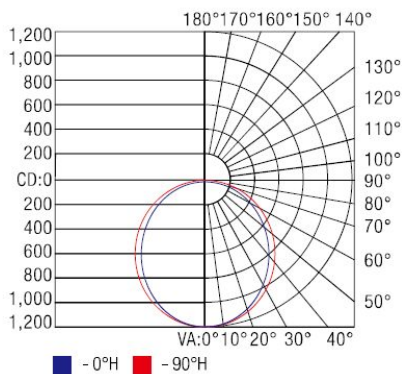

| | Center Beam lux | Beam Width | |
|----|-----------------|------------|-------|
| 1m | 1,172.7 lux | 2.7m | 3.4m |
| 2m | 293.2 lux | 5.5m | 6.8m |
| 3m | 130.3 lux | 8.2m | 10.2m |
| 4m | 73.3 lux | 10.9m | 13.6m |
| 5m | 46.9 lux | 13.7m | 17.0m |

■ Vertical: 107.5° ■ Horizontal: 119.1°

5. Application information

- 1.Underpasses
- 2.Subways
- 3.Warehouses
- 4.Cae parks

6. Package & Certification

| Item | Dimensions(L*W*H) | Qty | G.W |
|--------------------------------|-------------------|------|--------|
| ICL-LPL-IP65-900mm-SMD2835-36W | 960*470*220mm | 6pcs | 14.6KG |

7. Mounting

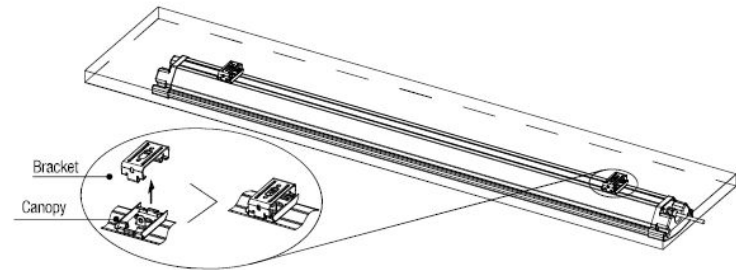
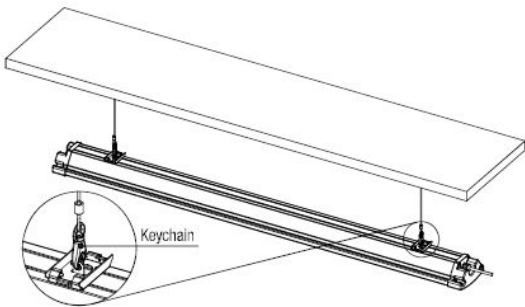

1. Product dimension:

ICL-LPL-IP65-1200mm-SMD2835-45W



2. Key features

1. 100 lm/W , a direct replacement for T8(2*36W) , T5(2*28W), 50% energy saving .
2. 120D beam available for optimal lighting effects
3. High impact PC diffuser with internal linear prisms ensures uniformity of light
4. Extruded aluminum housing , anodized , corrosion resistant
5. Injection-molded PC end caps
6. Integrated LED light engine eliminates the need for relamping
7. A range of mounting options for use in different applications
8. Emergency and occupancy sensing versions are available
9. 5-year warranty offers complete peace of mind

3. Specification

| Model No. | Spec |
|---------------------------------|------------------------------|
| ICL-LPL-IP65-1200mm-SMD2835-45W | |
| Input Power | 45W |
| Light output: | 4,500lm |
| Efficacy: | 100lm/W |
| LED lamp: | SMD2835 LEDs |
| CCT: | 3000K ,4000K ,5000K |
| CRI | 80 |
| Beam angle: | 120D |
| Optical cover: | Polycarbonate ,opal |
| LED driver: | MeanWell/Philips |
| Input voltage: | 90-305V AC,50/60Hz |
| Dimming: | Fixed output ,1-10V,DALI |
| Optional functions: | Emergency ,Occupancy Sensing |
| IP rating: | IP65 |
| Lifetime: | 50,000hrs |
| Mounting: | Suspended/Ceiling/Wall |

4. Dimension and Photometrics

Dimensions

Weight: 2.8 Kg

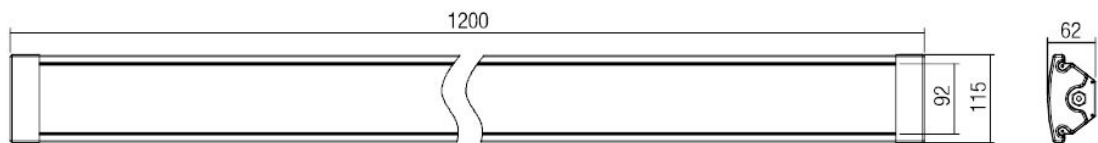

Photometrics

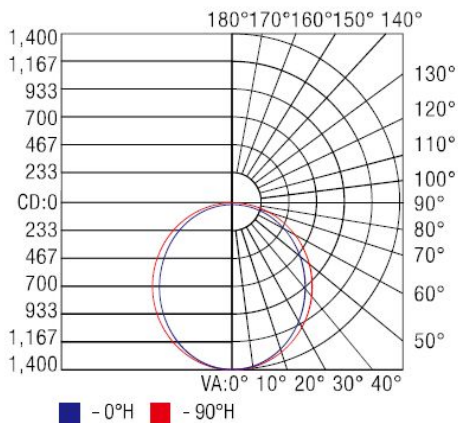

| | Center Beam lux | Beam Width |
|----|-----------------|-------------|
| 1m | 1,353,7 lux | 2,9m 3,4m |
| 2m | 338,4 lux | 5,8m 6,9m |
| 3m | 150,4 lux | 8,7m 10,3m |
| 4m | 84,6 lux | 11,5m 13,8m |
| 5m | 54,1 lux | 14,4m 17,2m |

■ Vertical: 110.5° ■ Horizontal: 119.7°

5. Application information

- 1.Underpasses
- 2.Subways
- 3.Warehouses
- 4.Cae parks

6. Package & Certification

| Item | Dimensions(L*W*H) | Qty | G.W |
|---------------------------------|-------------------|------|--------|
| ICL-LPL-IP65-1200mm-SMD2835-45W | 1260*470*220mm | 6pcs | 18.4KG |

7. Mounting

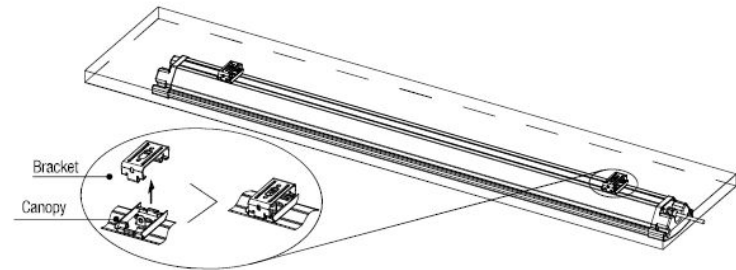
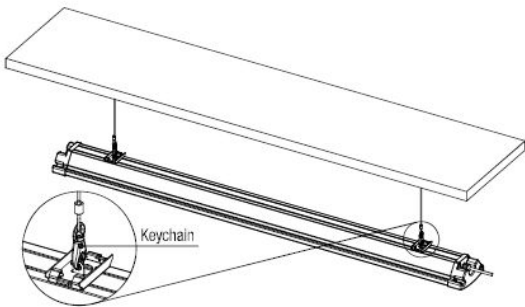

1. Product dimension:

ICL-LPL-IP65-1500mm-SMD2835-60W



2. Key features

- 1.100 lm/W , a direct replacement for T8(2*58W) , T5(2*54W),50% energy saving .
- 2.120D beam available for optimal lighting effects
- 3.High impact PC diffuser with internal linear prisms ensures uniformity of light
- 4.Extruded aluminum housing , anodized ,corrosion resistant
- 5.Injection-molded PC end caps
- 6.Integrated LED light engine eliminates the need for relamping
- 7.A range of mounting options for use in different applications
- 8.Emergency and occupancy sensing versions are available
- 9.5-year warranty offers complete peace of mind

3. Specification

| Model No. | Spec |
|---------------------------------|------------------------------|
| ICL-LPL-IP65-1500mm-SMD2835-60W | |
| Input Power | 60W |
| Light output: | 6,000lm |
| Efficacy: | 100lm/W |
| LED lamp: | SMD2835 LEDs |
| CCT: | 3000K ,4000K ,5000K |
| CRI | 80 |
| Beam angle: | 120D |
| Optical cover: | Polycarbonate ,opal |
| LED driver: | MeanWell/Philips |
| Input voltage: | 90-305V AC,50/60Hz |
| Dimming: | Fixed output ,1-10V,DALI |
| Optional functions: | Emergency ,Occupancy Sensing |
| IP rating: | IP65 |
| Lifetime: | 50,000hrs |
| Mounting: | Suspended/Ceiling/Wall |

4. Dimension and Photometrics

Dimensions

Weight: 3.4 Kg

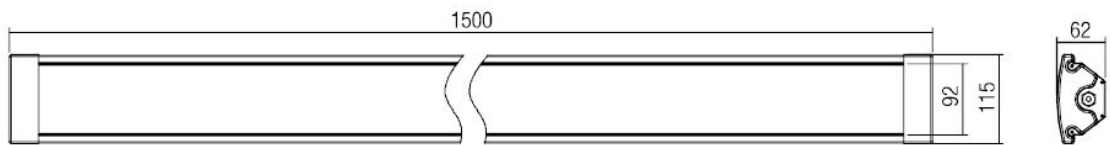

Photometrics

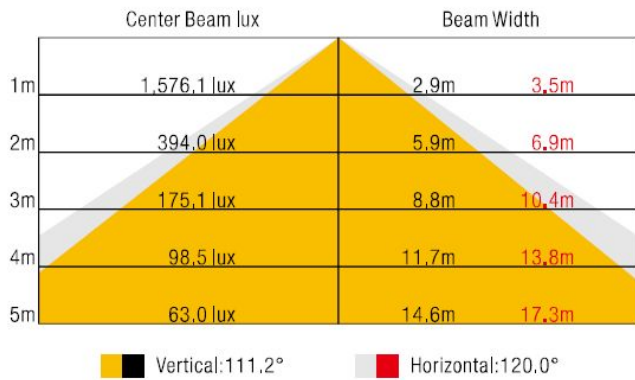
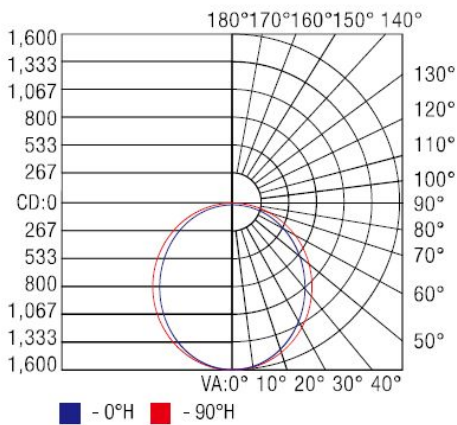

5. Application information

- 1.Underpasses
- 2.Subways
- 3.Warehouses
- 4.Cae parks

6. Package & Certification

| Item | Dimensions(L*W*H) | Qty | G.W |
|---------------------------------|-------------------|------|--------|
| ICL-LPL-IP65-1500mm-SMD2835-60W | 1560*470*220mm | 6pcs | 22.2KG |

7. Mounting

